

ARCHI[®]

MEDTORQUE

Product Catalog

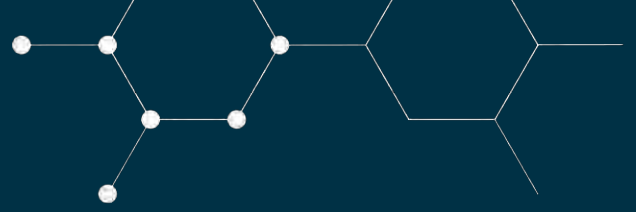



Solutions Come Standard

In today's highly competitive orthopedic industry, you need a partner that is **solution-oriented** and focused on helping you successfully bring your product to market. That's why ARCH-MedTorque's portfolio of products provides you with extensive **standard options** as well as **customizable solutions** that are engineered to fit your needs. Regardless of your requirements, with ARCH-MedTorque, **Solutions Come Standard.**



Table of Contents

| | |
|--|-----------|
| New Products..... | 4 |
| • Vantage 2-Color Handle Components | 4 |
| • Vantage 2-Color Fixed, Ratcheting, and Torque-Limiting Drivers | 5 |
| Handle Components..... | 6 |
| • Jeweler Axial Handle (Long & Short) / Petite Axial Handle / Renegade Axial Handle | 7 |
| • Mini Axial Handle / Standard Axial Handle / Slim-Standard Axial Handle | 7 |
| • Agile Axial Handle (Mini & Large) / Curette Axial Handle (Long & Short) / Palm Axial Handle | 8 |
| • Ball Handle / Wrangler Axial Handle/ Bandit Axial Handle | 8 |
| • Triumph Axial Handle / Vanguard Axial Handle / Magnum Axial Handle | 9 |
| • T-Handles (Small, Medium, Large) / Silicone Finger Grips | 9 |
| Handles with Fixed Couplings..... | 10 |
| • Female and Male Coupling Connections | 10 |
| • Jeweler Axial Handle (Long & Short) / Petite Axial Handle / Renegade Axial Handle / Mini Axial Handle | 11 |
| • Standard Axial Handle / Slim-Standard Axial Handle / Agile Axial Handle (Mini & Large) / Palm Axial Handle | 12 |
| • Curette Axial Handle / T-Handle (Small, Medium, Large) / Slim T-Handle / Mondo T-Handle | 13 |
| Ratcheting Handles with Couplings..... | 14 |
| • Jeweler Axial Handle (Long & Short) / Petite Axial Handle / Renegade Axial Handle / Mini Axial Handle | 15 |
| • Standard Axial Handle / Slim-Standard Axial Handle / Agile Axial Handle (Mini & Large) / Palm Axial Handle | 16 |
| • T-Handle (Small, Medium, Large) / Mondo T-Handle | 17 |
| Torque-Limiting Handles with Coupling..... | 18 |
| • Torque Adapter / Jeweler Axial Handle (Long & Short) / Petite Axial Handle | 18 |
| • Mini Axial Handle / Slim-Standard Axial Handle / Standard Axial Handle / Palm Axial Handle | 19 |
| • T-Handle (Small, Medium, Large) / Mondo T-Handle | 20 |
| • Torque-Limiting Ratchet Drivers | 21 |
| How to Specify Your Handle..... | 21 |
| Disc Prep and Spine Instruments..... | 22 |
| Other Products & Services Offered by MedTorque..... | 23 |

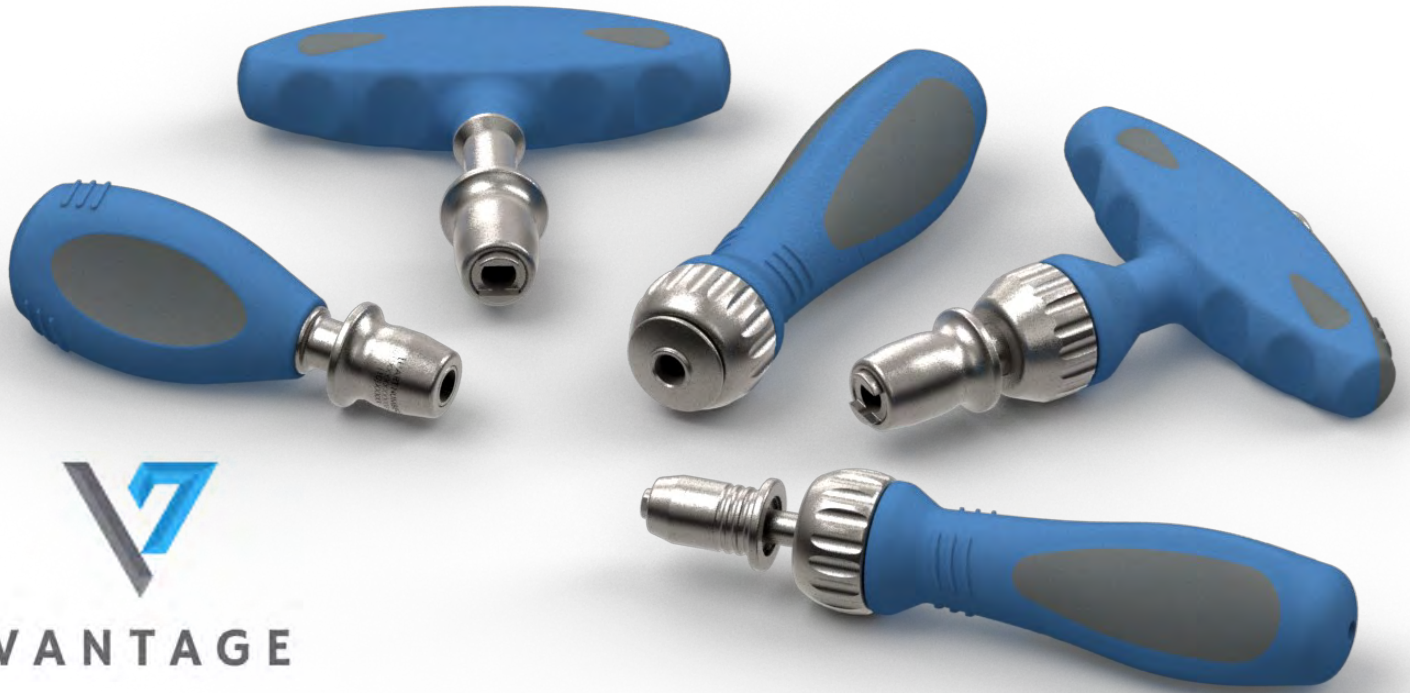
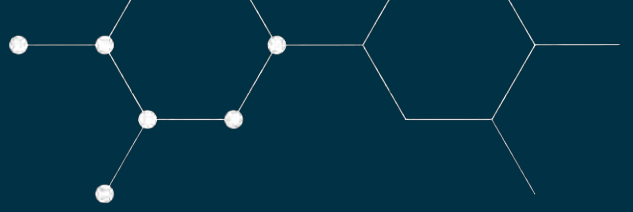

VANTAGE

Two-Color Handled Instruments

Our VANTAGE line of two-color handles provide you with an ergonomic solution that allows for expanded branding capabilities. The Axial, Palm, and T-handle styles can be configured with any of our existing instrument features.

Send us your color requirements and we'll create a customized handle to match your branding needs. The option to add a logo gives you additional branding options along with your custom color combination.

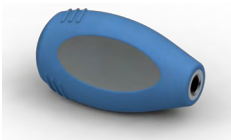

Vantage-P



Vantage-A

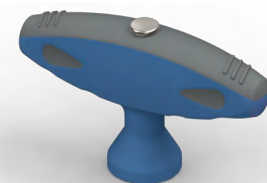

Vantage-T

Vantage Handle Components

| Part # | Description |
|--------|---|
| 3HP40 | Vantage-P Handle / FR: 3/8"-24 / RR: Cannulation |
| 3HP41 | Vantage-P Handle / FR: 3/8"-24 / RR: Cap |
| 3HS45 | Vantage-A Handle / FR: 5/16-24" (MES-018) / RR: Cannulation |
| 3HS47 | Vantage-A Handle / FR: 5/16-24" (MES-018) / RR: Cap |
| 3HT47 | Vantage-T Handle / FR: Shank / RR: Cap |
| 3HT48 | Vantage-T Handle / FR: Shank / RR: Cannulated Cap |

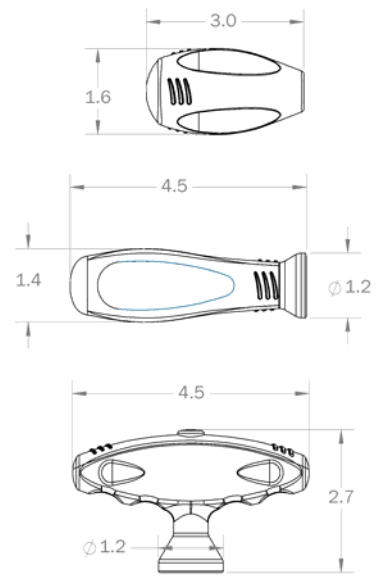

New Products

Vantage - Fixed Drivers

| Part # | Description |
|--------|--|
| 1FP29 | Fixed / Vantage-P Handle / Large Hudson Coupling / Cannulated |
| 1FP30 | Fixed / Vantage-P Handle / 1/4" SQ Coupling / Cannulated* |
| 1FP31 | Fixed / Vantage-P Handle / AO Pull Coupling / Cannulated |
| 1FS47 | Fixed / Vantage-A Handle / 1/4" SQ Coupling / Cannulated |
| 1FS48 | Fixed / Vantage-A Handle / AO Pull Coupling / Cannulated* |
| 1FS50 | Fixed / Vantage-A Handle / ZSJ Hall Coupling / Cannulated |
| 1FS51 | Fixed / Vantage-A Handle / Large Hudson Coupling / Cannulated |
| 1FT76 | Fixed / Vantage-T Handle / Large Hudson Coupling / Cap |
| 1FT77 | Fixed / Vantage-T Handle / Large Hudson Coupling / Cap / Cann* |
| 1FT79 | Fixed / Vantage-T Handle / AO Pull Coupling / Cap |
| 1FT80 | Fixed / Vantage-T Handle / 1/4" SQ Coupling / Cap |
| 1FT81 | Fixed / Vantage-T Handle / ZSJ Hall Coupling / Cap |

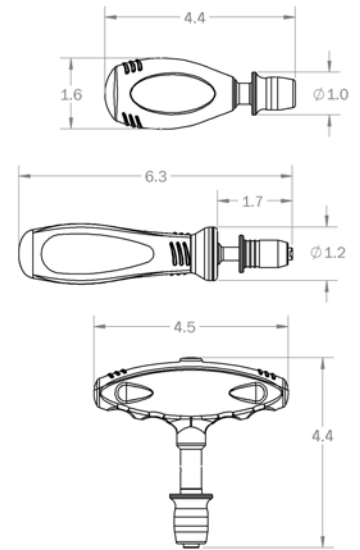

Vantage - Ratcheting Drivers

| Part # | Description |
|--------|---|
| 1RS24 | Ratchet / Vantage-A Handle / Large Hudson Coupling / Cannulated |
| 1RS25 | Ratchet / Vantage-A Handle / 1/4" SQ Coupling / Cannulated |
| 1RS26 | Ratchet / Vantage-A Handle / 1/4" SQ Push-Lock Coupling / Cann |
| 1RS27 | Ratchet / Vantage-A Handle / AO Pull Coupling / Cannulated* |
| 1RS29 | Ratchet / Vantage-A Handle / ZSJ Hall Coupling / Cannulated |
| 1RS32 | Ratchet / Vantage-A Handle / 3/16" SQ Coupling / Cannulated |
| 1RS33 | Ratchet / Vantage-A Handle / Large Hudson Coupling / Cannulated |
| 1RT47 | Ratchet / Vantage-T Handle / Large Hudson Coupling / Cap |
| 1RT48 | Ratchet / Vantage-T Handle / 1/4" SQ Coupling / Cap |
| 1RT50 | Ratchet / Vantage-T Handle / ZSJ Hall Coupling / Cap |

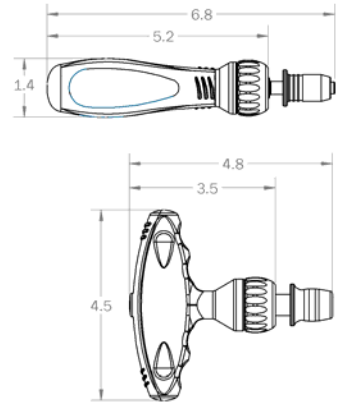

Vantage - Torque-Limiting Drivers

| Part # | Description |
|--------|---|
| 1TP15 | Torque-Limiting Driver / Vantage-P Handle / AO Push-Lock Cplg* |
| 1TP16 | Torque-Limiting Driver / Vantage-P Handle / Pull AO Coupling |
| 1TP17 | Torque-Limiting Driver / Vantage-P Handle / ZSH Hall Coupling |
| 1TP18 | Torque-Limiting Driver / Vantage-P Handle / Large Hudson Coupling |
| 1TP19 | Torque-Limiting Driver / Vantage-P Handle / 1/4" SQ Coupling |
| 1TS27 | Torque-Limiting Driver / Vantage-A Handle / 1/4" SQ Coupling* |
| 1TS28 | Torque-Limiting Driver / Vantage-A Handle / AO Pull Coupling |
| 1TS29 | Torque-Limiting Driver / Vantage-A Handle / ZSJ Hall Coupling |
| 1TS30 | Torque-Limiting Driver / Vantage-A Handle / Large Hudson Coupling |
| 1TTL25 | Torque-Limiting Driver / Vantage-T Handle / 1/4" SQ Coupling* |
| 1TTL27 | Torque-Limiting Driver / Vantage-T Handle / AO Pull Coupling |
| 1TTL28 | Torque-Limiting Driver / Vantage-T Handle / ZSJ Hall Coupling |
| 1TTL29 | Torque-Limiting Driver / Vantage-T Handle / Large Hudson Coupling |

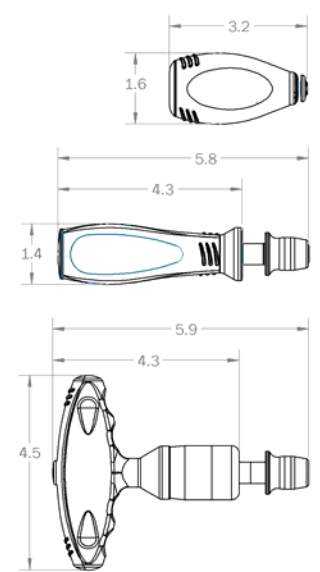

*Item Shown

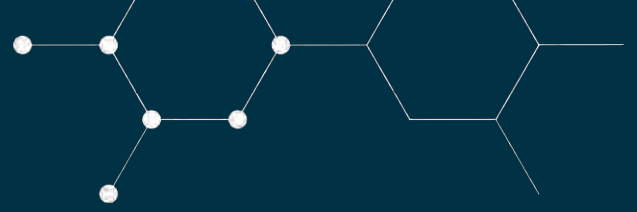

Handle Components with Threaded Connection

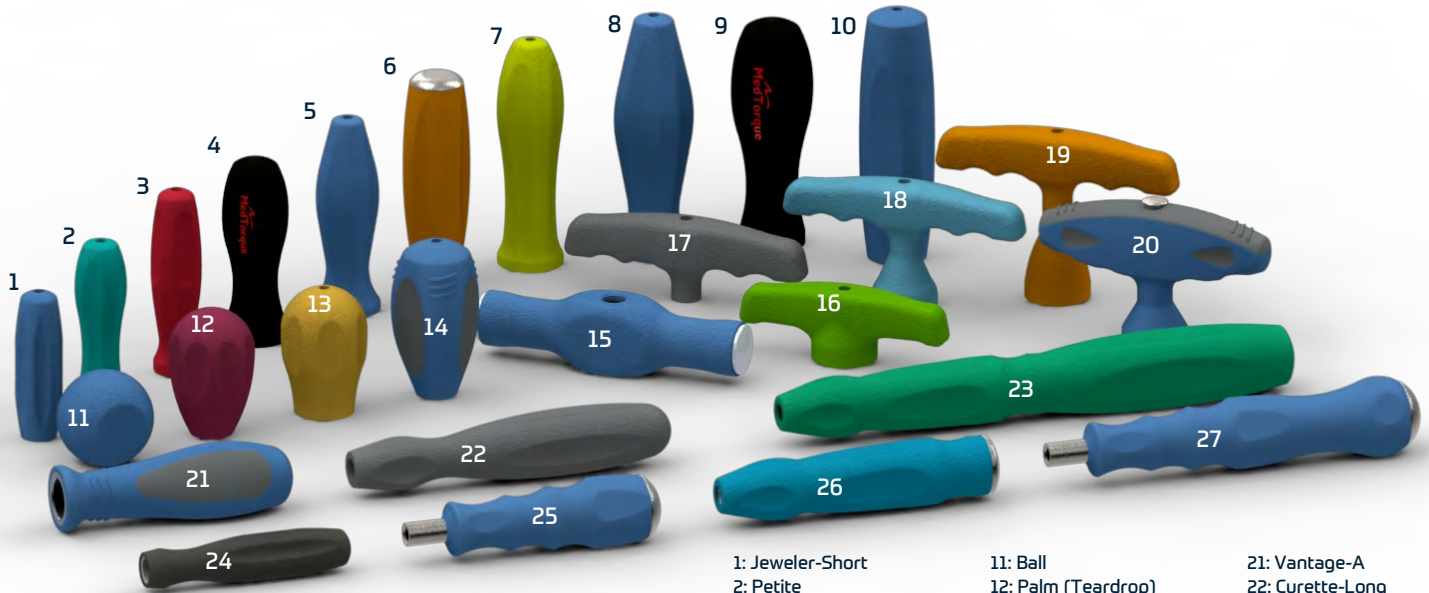

- | | | |
|----------------------------|---------------------|------------------|
| 1: Jeweler-Short | 11: Ball | 21: Vantage-A |
| 2: Petite | 12: Palm (Teardrop) | 22: Curette-Long |
| 3: Renegade | 13: Palm (Wide) | 23: Triumph |
| 4: Mini (w/ Pad Print) | 14: Vantage-P | 24: Jeweler-Long |
| 5: Agile—Mini | 15: Mondo T | 25: Bandit |
| 6: Curette—Short | 16: Small T | 26: Vanguard |
| 7: Slim-Standard | 17: Slim T | 27: Wrangler |
| 8: Agile—Large | 18: Medium T | |
| 9: Standard (w/ Pad Print) | 19: Large T | |
| 10: Magnum | 20: Vantage-T | |

ARCH-MedTorque Handle Offering

ARCH-MedTorque’s handles are designed to easily integrate the comfort and style of a silicone handle with the function of your specialized instrument. Specify a standard MedTorque handle in your next project and be confident your timelines will be met with quality craftsmanship.

- Select ARCH-MedTorque handles can be fitted with stainless steel caps and most come cannulated as standard.
- Mold any standard ARCH-MedTorque handle in your company-specific Pantone® Matching System color.
- Select styles allow you to easily add your logo via pad printing or laser engraving.

Looking for something unique? From custom silicone handle styles to over-molding of instruments, ARCH-MedTorque’s molding expertise and capabilities allow you countless options when creating that unique look and feel your instruments need to stand apart from the competition.

Threaded Connections on Handle Components

ARCH-MedTorque’s handle components utilize standardized threaded geometry. The following MedTorque design standards are utilized on most handle component configurations. Contact your MedTorque representative for dimensions of the mating male threaded connection.

- MES-015: 1/4”-20 UNC Thread
- MES-016: 3/8”-16 UNC Thread
- MES-017: 1/2”-20 UNF Thread
- MES-018: 5/16”-24 UNF Thread
- MES-022: 1/4”-20 UNC Thread (Deep Thread)



Handle Components

Jeweler Axial Handle



| Part # | Description |
|--------|--|
| 3HJ5 | Short Jeweler Axial Handle / FR: 1/4-20 UNC (MES-015) / RR: Ø.16 Cann* |
| 3HJ7 | Short Jeweler Axial Handle / FR: 1/4-20 UNC (MES-015) / RR: Cap |
| 3HJ8 | Short Jeweler Axial Handle / FR: 1/4-20 UNC (MES-015) / RR: Spin Cap |
| 3HJ17 | Long Jeweler Axial Handle / FR: 1/4-20 UNC (MES-015) / RR: Cap |
| 3HJ19 | Long Jeweler Axial Handle / FR: 1/4-20 UNC (MES-015) / RR: Ø.16 Cann* |

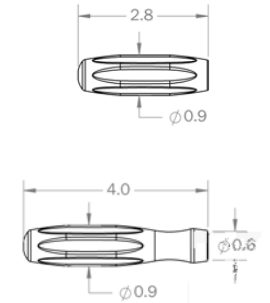

Petite Axial Handle



| Part # | Description |
|--------|--|
| 3HM4 | Petite Axial Handle / FR: 1/4-20 UNC (MES-015) / RR: Ø.16 Cannulation* |
| 3HM5 | Petite Axial Handle / FR: 1/4-20 UNC (MES-015) / RR: Ø.16 Cannulated Cap |
| 3HM6 | Petite Axial Handle / FR: 1/4-20 UNC (MES-015) / RR: Cap |

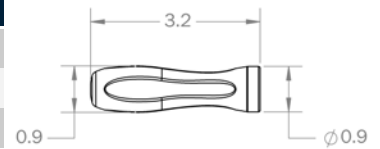

Renegade Axial Handle



| Part # | Description |
|--------|---|
| 3HM25 | Renegade Axial Handle / FR: 1/4-20 UNC (MES-022) / RR: Ø.16 Cann* |
| 3HM26 | Renegade Axial Handle / FR: 1/4-20 UNC (MES-022) / RR: Cap |

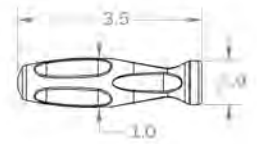

Mini Axial Handle



| Part # | Description |
|--------|--|
| 3HM7 | Mini Axial Handle / FR: 1/4-20 UNC (MES-015) / RR: Ø.20 Cannulation* |
| 3HM8 | Mini Axial Handle / FR: 1/4-20 UNC (MES-015) / RR: Ø.20 Cannulated Cap |
| 3HM9 | Mini Axial Handle / FR: 1/4-20 UNC (MES-015) / RR: Cap |

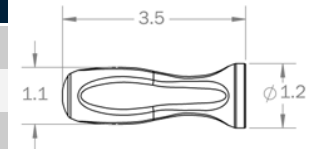

Standard Axial Handle



| Part # | Description |
|--------|--|
| 3HS8 | Standard Axial Handle / FR: 5/16-24 UNF (MES-018) / RR: Ø.20 Cann* |
| 3HS12 | Standard Axial Handle / FR: 5/16-24 UNF (MES-018) / RR: Cap |

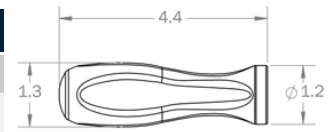

Slim-Standard Axial Handle



| Part # | Description |
|--------|---|
| 3HS16 | Slim-Standard Axial Handle / FR: 5/16-24 UNF (MES-018) / RR: Ø.20 Cann* |
| 3HS20 | Slim-Standard Axial Handle / FR: 5/16-24 UNF (MES-018) / RR: Cap |

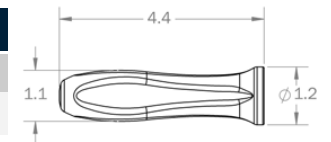

Handle Components

*Item Shown

Dimensions shown are approximate and for reference only. Contact an ARCH-MedTorque representative for exact dimensions.

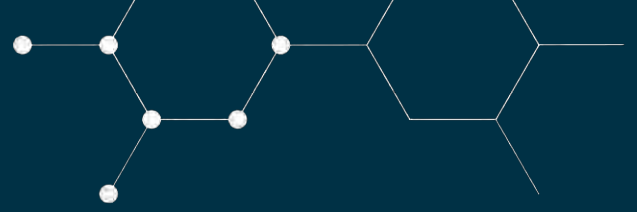

Mini



Large

Agile Axial Handle

| Part # | Description |
|--------|--|
| 3HM13 | Agile Mini Handle / FR: 5/16-24 UNF (MES-018) / RR: Ø.20 Cannulation |
| 3HL3 | Agile Large Handle / FR: 3/8-16 UNC (MES-016) / RR: Ø.20 Cannulation |
| 3HL5 | Agile Large Handle / FR: 5/16-24 UNF (MES-018) / RR: Ø.20 Cann |

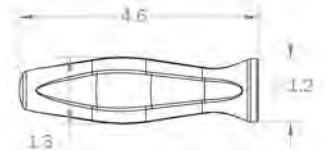
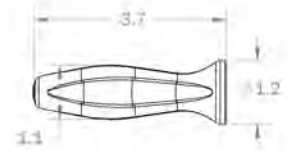

Short



Curette Axial Handle

| Part # | Description |
|--------|--|
| 3HC1 | Curette Axial Handle / Front: 3/8-16 UNC / Rear: Ø.20 Cannulation* |
| 3HC6 | Curette Axial Handle / Front: 3/8-16 UNC / Rear: Cap |
| 3HC7 | Short Curette Axial Handle / Front: 3/8-16 UNC / Rear: Cap* |
| 3HC11 | Short Curette Axial Handle / Front: 3/8-16 UNC / Rear: Ø.20 Cann |

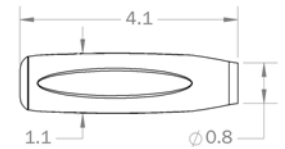
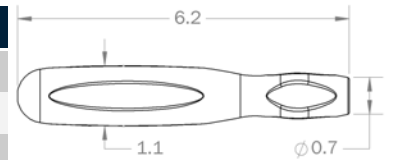

Palm Handle

| Part # | Description |
|--------|--|
| 3HP2 | Palm Handle / Front: 5/16-24 UNF (MES-018) / Rear: Solid Silicone* |
| 3HP5 | Palm Handle / Front: 3/8-16 UNC (MES-016) / Rear: Cap |
| 3HP8 | Palm Handle / Front: 5/16-24 UNF (MES-018) / Rear: Cap |
| 3HP9 | Palm Handle / Front: 5/16-24 UNF (MES-018) / Rear: Ø.20 Cann Cap |
| 3HP10 | Palm Handle / Front: 3/8-16 UNC (MES-016) / Rear: Solid Silicone |

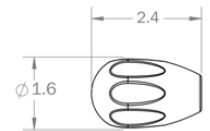

Ball Handle

| Part # | Description |
|--------|---|
| 3HB1 | Handle / Ball / Front: 1/2-20 UNF (MES-017) / Rear: Solid Silicone* |
| 3HB3 | Handle / Ball / Front: 1/2-20 UNF (MES-017) / Rear: Cap |

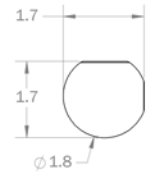

Wrangler Axial Handle

| Part # | Description |
|--------|---|
| 3HA9 | Wrangler Axial Handle / FR: M8 x 1.25-6H / RR: Cap |
| 3HA13 | Wrangler Axial Handle / FR: M8 x 1.25-6H / RR: Ø.20 Cannulation |

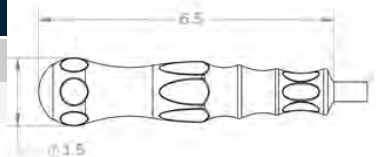

Bandit Axial Handle

| Part # | Description |
|--------|--|
| 3HA11 | Bandit Axial Handle / FR: M8 x 1.25-6H / RR: Cap |

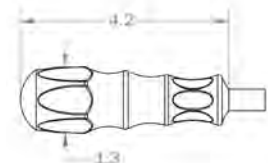

*Item Shown



Handle Components

Triumph Axial Handle

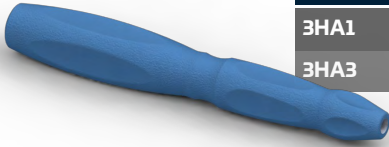

| Part # | Description |
|--------|---|
| 3HA1 | Triumph Axial Handle / FR: 3/8-16 UNC / RR: Ø.20 Cannulation* |
| 3HA3 | Triumph Axial Handle / FR: 3/8-16 UNC / RR: Cap |

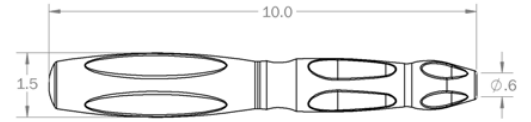

Vanguard Axial Handle



| Part # | Description |
|--------|---|
| 3HA5 | Vanguard Axial Handle / FR: 3/8-16 UNC / RR: Cap* |

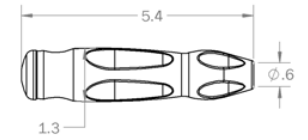

Magnum Axial Handle



| Part # | Description |
|--------|--|
| 3HA6 | Magnum Axial Handle / Front:: 1/2-20 UNF / Rear: Ø.20 Cannulation* |
| 3HA7 | Magnum Axial Handle / Front: 1/2-20 UNF / Rear: 1/2-20 UNF |
| 3HA8 | Magnum Axial Handle / Front: 1/2-20 UNF / Rear: Cap |

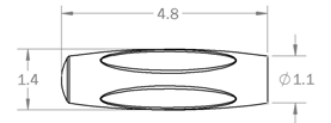

T-Handles

Small



| Part # | Description |
|--------|--|
| 3HT11 | Medium T-Handle / Front:: 1/4-20 UNC / Rear: Ø.20 Cannulation* |
| 3HT12 | Small T-Handle / Front: 1/4-20 UNC / Rear: Ø.20 Cannulation |
| 3HT13 | Large T-Handle / Front: 1/4-20 UNC / Rear: Ø.20 Cannulation |
| 3HT22 | Mondo T-Handle / Front: 3/8-24 UNF / Top & Side Caps |

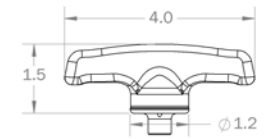

Medium

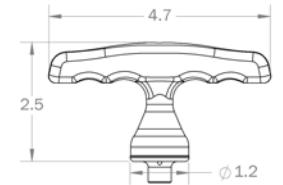

Large

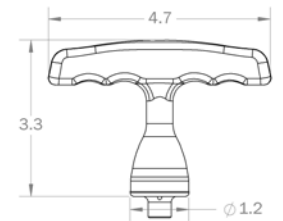

Mondo

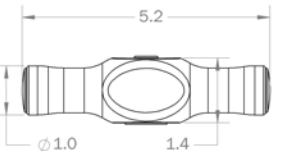

Silicone Finger Grips



| Part # | Description |
|--------|-------------------------------------|
| 3FG1 | Finger Grip / Silicone / 4 Scallop* |
| 3FG2 | Finger Grip / Silicone / Flat |

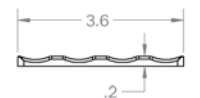

See page 21 for instructions on how to specify a handle component.

Dimensions shown are approximate and for reference only. Contact an ARCH-MedTorque representative for exact dimensions.

*Item Shown

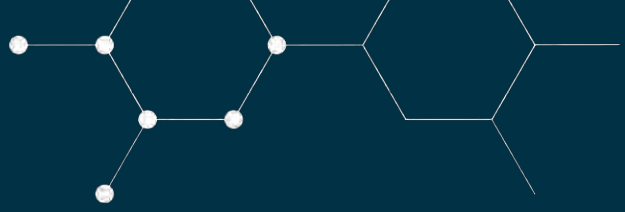

Handles with Fixed Couplings



Female Coupling Connections

ARCH-MedTorque's quick connect couplings fit the industry's most common male configurations and can be specified with any handle style. Their all stainless steel construction and tight tolerance manufacture ensures a secure fit every time. Our couplings are available on all fixed, ratcheting, and torque-limiting drivers.



Male Coupling Connections

Contact an ARCH-MedTorque representative to request a print of one of our engineered standards when designing your mating shaft. Use the identifications below when specifying the geometry on a mating shaft. Have a quick connection not listed in this catalog? ARCH-MedTorque can work with your design team to create a custom coupling that can be attached to any ARCH-MedTorque handle.

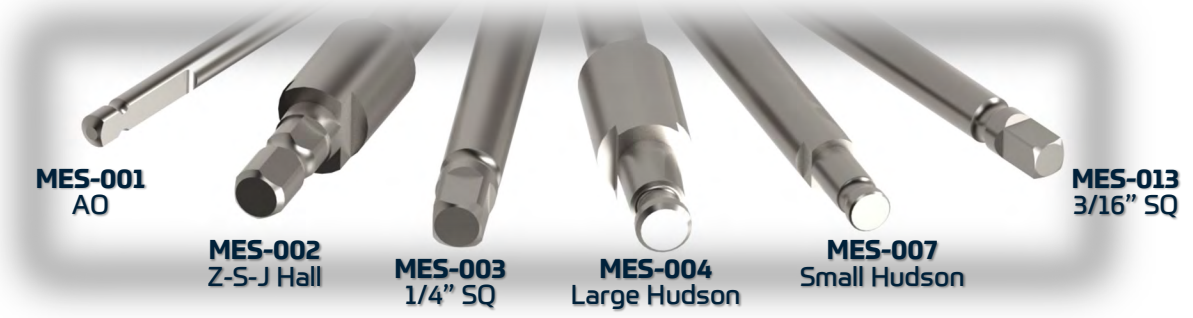

Fixed Handles

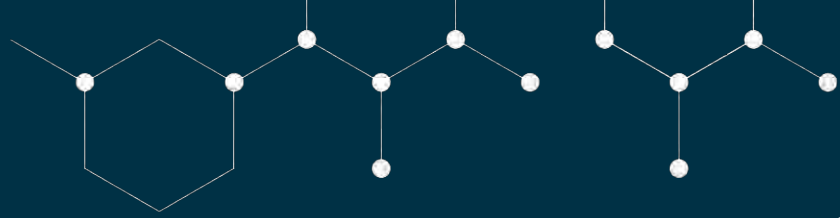

Jeweler Axial Handle

| Part # | Description |
|--------|--|
| 1HJ1 | Fixed / Jeweler Axial Handle / AO Pull Coupling / Spin Cap / Cannulated* |
| 1HJ2 | Fixed / Jeweler Axial Handle / AO Push Coupling / Cannulated |
| 1HJ3 | Fixed / Jeweler Axial Handle / AO Pull Coupling / Spin Cap |
| 1HJ6 | Fixed / Jeweler Axial Handle / AO Pull - Short / Spin Cap / Cannulated |
| 1HJ9 | Fixed / Jeweler Axial Handle / AO Pull - Short / Spin Cap |

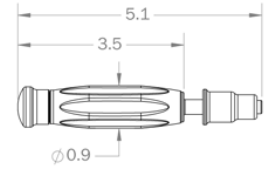

Long Jeweler Axial Handle

| Part # | Description |
|--------|--|
| 1HJ11 | Fixed / Long Jeweler Axial Handle / AO Pull Coupling / Spin Cap / Cann |
| 1HJ12 | Fixed / Long Jeweler Axial Handle / AO Push Coupling / Cannulated |
| 1HJ13 | Fixed / Long Jeweler Axial Handle / AO Pull Coupling / Spin Cap |
| 1HJ18 | Fixed / Long Jeweler Axial Handle / AO Pull Coupling / Solid Cap |
| 1HJ19 | Fixed / Long Jeweler Axial Handle / AO Pull Coupling / Cannulated* |

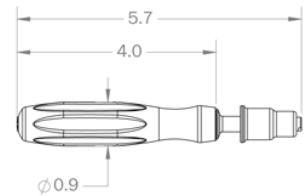

Petite Axial Handle

| Part # | Description |
|--------|---|
| 1FM21 | Fixed / Petite Axial Handle / AO Pull Coupling / Cannulated |
| 1FM25 | Fixed / Petite Axial Handle / AO Push Coupling / Cannulated* |
| 1FM29 | Fixed / Petite Axial Handle / 3/16" SQ Pull Coupling / Cannulated |

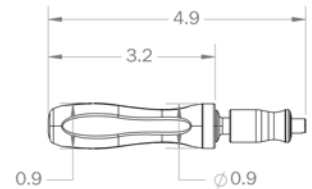

Renegade Axial Handle

| Part # | Description |
|--------|--|
| 1FM41 | Fixed / Renegade Axial Handle / AO Pull Coupling / Cannulated* |
| 1FM42 | Fixed / Renegade Axial Handle / AO Pull Coupling / Rear Cap |
| 1FM43 | Fixed / Renegade Axial Handle / 3/16" SQ Coupling / Cannulated |
| 1FM44 | Fixed / Renegade Axial Handle / Small Hudson / Rear Cap |

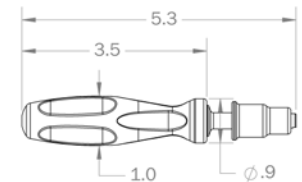

Mini Axial Handle

| Part # | Description |
|--------|---|
| 1FM1 | Fixed / Mini Axial Handle / AO Pull Coupling / Cannulated |
| 1FM2 | Fixed / Mini Axial Handle / ZSJ Hall Pull Coupling / Cannulated |
| 1FM3 | Fixed / Mini Axial Handle / Large Hudson Pull Coupling / Cannulated |
| 1FM4 | Fixed / Mini Axial Handle / 1/4" SQ Pull Coupling / Cannulated* |
| 1FM5 | Fixed / Mini Axial Handle / AO Push Coupling / Cannulated |

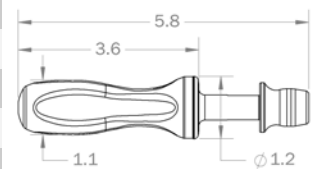

*Item Shown

Dimensions shown are approximate and for reference only. Contact an ARCH-MedTorque representative for exact dimensions.

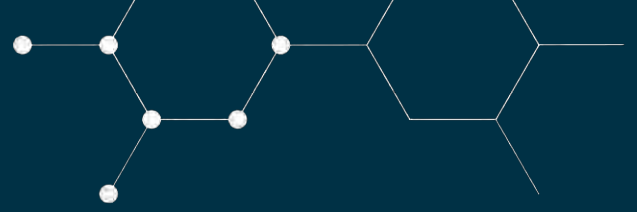

Standard Axial Handle

| Part # | Description |
|--------|---|
| 1FS1 | Fixed / Std Axial Handle / AO Pull Coupling / Cannulated |
| 1FS2 | Fixed / Std Axial Handle / ZSJ Hall Coupling / Cannulated |
| 1FS3 | Fixed / Std Axial Handle / Large Hudson Coupling / Cannulated* |
| 1FS4 | Fixed / Std Axial Handle / 1/4" SQ Coupling / Cannulated |
| 1FS5 | Fixed / Std Axial Handle / AO Push Coupling / Cannulated |
| 1FS24 | Fixed / Std Axial Handle / Large Hudson Coupling / Cannulated Cap |
| 1FS29 | Fixed / Std Axial Handle / ZSJ Hall Coupling / Cannulated Cap |
| 1FS30 | Fixed / Std Axial Handle / 1/4" SQ Coupling / Cannulated Cap |
| 1FS41 | Fixed / Std Axial Handle / 3/16" SQ Push-Lock Coupling / Cannulated |
| 1FS49 | Fixed / Std Axial Handle / Keyless Chuck / Cannulated |

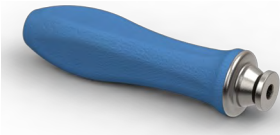
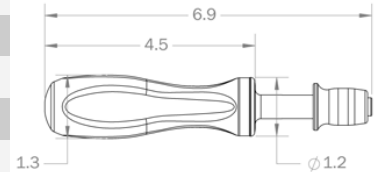

Slim-Standard Axial Handle

| Part # | Description |
|--------|---|
| 1FS11 | Fixed / Slim-Standard Axial Handle / AO Pull Coupling / Cannulated |
| 1FS12 | Fixed / Slim-Standard Axial Handle / ZSJ Hall Coupling / Cannulated |
| 1FS13 | Fixed / Slim-Standard Axial Handle / Large Hudson Coupling / Cann* |
| 1FS14 | Fixed / Slim-Standard Axial Handle / 1/4" SQ Coupling / Cannulated |
| 1FS15 | Fixed / Slim-Standard Axial Handle / AO Push Coupling / Cannulated |
| 1FS42 | Fixed / Slim Std Axial Handle / 3/16" SQ Push-Lock Coupling / Cann |

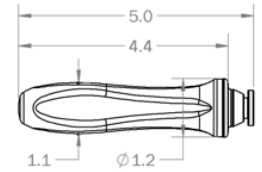

Large

Agile Fixed Handles

| Part # | Description |
|--------|--|
| 1FL2 | Fixed / Agile Large / ZSJ Hall Coupling / Cannulated |
| 1FL1 | Fixed / Agile Large / AO Pull Coupling / Cannulated |
| 1FL3 | Fixed / Agile Large / Large Hudson Coupling / Cannulated |
| 1FL4 | Fixed / Agile Large / 1/4" SQ Coupling / Cannulated |
| 1FM31 | Fixed / Agile Mini / AO Pull Coupling / Cannulated* |
| 1FM34 | Fixed / Agile Mini / 1/4" SQ Coupling / Cannulated |

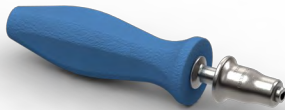
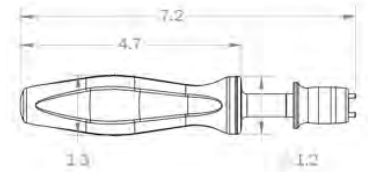

Mini

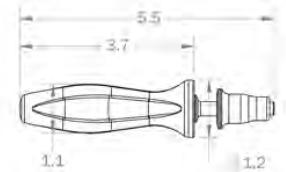

Palm Axial Handle

| Part # | Description |
|--------|---|
| 1FP1 | Fixed / Palm Axial Handle / AO Pull Coupling / Cannulated |
| 1FP2 | Fixed / Palm Axial Handle / ZSJ Hall Pull Coupling / Cannulated |
| 1FP3 | Fixed / Palm Axial Handle / Large Hudson Pull Coupling / Cannulated |
| 1FP4 | Fixed / Palm Axial Handle / 1/4" SQ Pull Coupling / Cannulated |
| 1FP5 | Fixed / Palm Axial Handle / AO Push Coupling / Cannulated |
| 1FP21 | Fixed / Palm Axial Handle / 1/4" SQ Low Profile Coupling / Cann* |

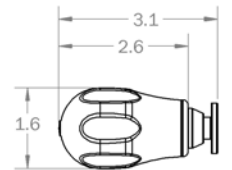

*Item Shown



Fixed Handles

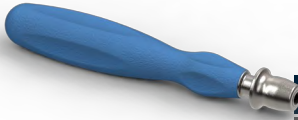
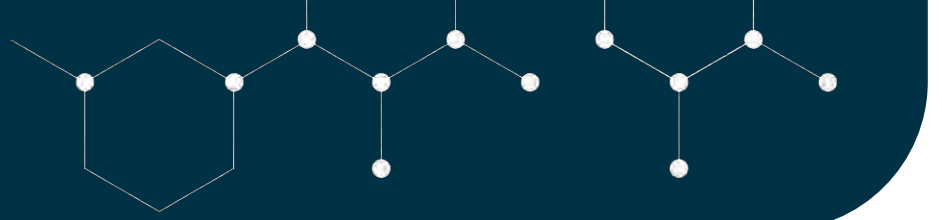

Curette Axial Handle

| Part # | Description |
|--------|--|
| 1FC1 | Fixed / Curette Axial Handle / AO Pull Coupling / Cannulated |
| 1FC2 | Fixed / Curette Axial Handle / ZSJ Hall Pull Coupling / Cannulated |
| 1FC3 | Fixed / Curette Axial Handle / Large Hudson Pull Coupling / Cann |
| 1FC4 | Fixed / Curette Axial Handle / 1/4" SQ Pull Coupling / Cannulated* |

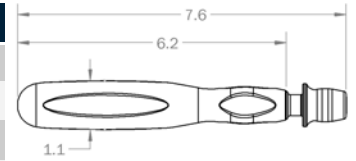

T-Handles

| Part # | Description |
|--------|--|
| 1FT6 | Fixed / Small T-Handle / AO Pull Coupling / Cannulated |
| 1FT7 | Fixed / Small T-Handle / ZSJ Hall Pull Coupling / Cannulated |
| 1FT8 | Fixed / Small T-Handle / Large Hudson Pull Coupling / Cannulated |
| 1FT9 | Fixed / Small T-Handle / 1/4" SQ Pull Coupling / Cannulated* |
| 1FT10 | Fixed / Small T-Handle / AO Push Coupling / Cannulated |
| 1FT18 | Fixed / Medium T-Handle / AO Pull Coupling |
| 1FT19 | Fixed / Medium T-Handle / ZSJ Hall Pull Coupling |
| 1FT20 | Fixed / Medium T-Handle / Large Hudson Pull Coupling |
| 1FT21 | Fixed / Medium T-Handle / 1/4" SQ Pull Coupling |
| 1FT1 | Fixed / Large T-Handle / AO Pull Coupling / Cannulated |
| 1FT2 | Fixed / Large T-Handle / ZSJ Hall Pull Coupling / Cannulated |
| 1FT3 | Fixed / Large T-Handle / Large Hudson Pull Coupling / Cannulated |
| 1FT4 | Fixed / Large T-Handle / 1/4" SQ Pull Coupling / Cannulated |
| 1FT5 | Fixed / Large T-Handle / AO Push Coupling / Cannulated |
| 1FT17 | Fixed / Slim T-Handle / 1/4" SQ Pull Coupling |
| 1FT26 | Fixed / Slim T-Handle / ZSJ Hall Pull Coupling* |
| 1FT27 | Fixed / Slim T-Handle / AO Pull Coupling |
| 1FT28 | Fixed / Slim T-Handle / Large Hudson Pull Coupling |
| 1FT30 | Fixed / Mondo T-Handle / ZSJ Hall Pull Coupling |
| 1FT31 | Fixed / Mondo T-Handle / Large Hudson Coupling* |
| 1FT32 | Fixed / Mondo T-Handle / 1/4" SQ Pull Coupling |



Small



Medium



Large



Slim



Mondo

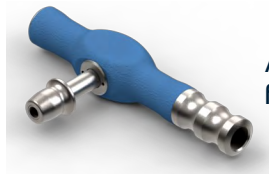

Ask about extension arms for our Mondo handles.

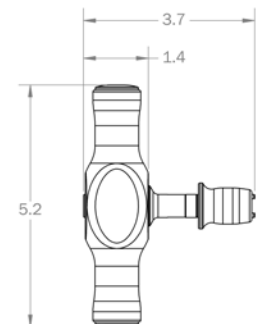
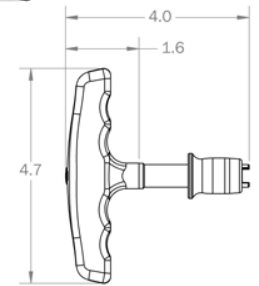
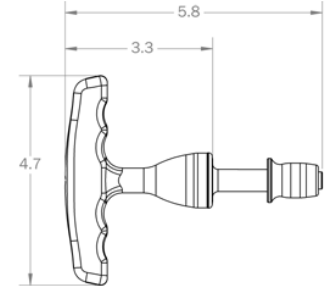
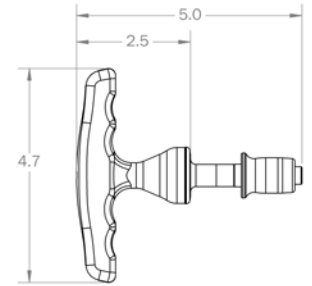
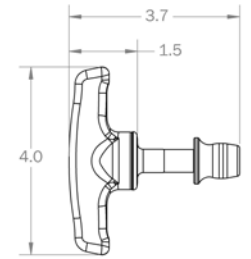

See page 21 for instructions on how to specify a fixed driver.

Dimensions shown are approximate and for reference only. Contact an ARCH-MedTorque representative for exact dimensions.

*Item Shown

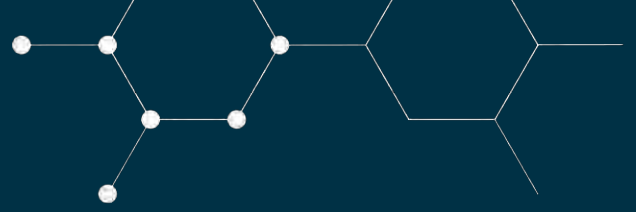

Ratcheting Handles with Couplings



TRI-GEAR™ Ratcheting Technology

MedTorque offers two styles of ratcheting drivers to meet your demanding needs.

- **TRI-GEAR™ Ultra-Mini:** Our *TRI-GEAR™ Ultra-Mini Ratcheting Technology* is ideal for applications for where smaller handles and drivers are required. Small, yet robust, the ultra-mini size packs a punch when coupled with many of our smaller profile handles such as the Petite Axial, Renegade or Jeweler handles.
- **TRI-GEAR™ Eclipse:** Our most recent development in ratcheting technology is the next generation in ratchet drivers for orthopedic and spinal surgery. This mechanism features the refined precision, control and feel your surgeons expect. With nearly twice as many teeth per revolution than that of competing products, this ratchet truly eclipses the competition. This mechanism fits many of our larger profile handles including the Mini Axial up to the Large T-Handle.

We know peace of mind and confidence is important. That's why ARCH-MedTorque has conducted extensive life cycle testing during development. This includes 300 autoclave cycles and thousands of actuations under torque load, demonstrating performance throughout the life of the instrument. Test summaries are available upon request.



Ratcheting Handles

Jeweler Axial Handle



| Part # | Description |
|--------|--|
| 1RUM1 | Ratchet / Jeweler Axial Handle / AO Pull Coupling / Spin Cap / Cann* |
| 1RUM2 | Ratchet / Jeweler Axial Handle / AO Push Coupling / Spin Cap / Cann |
| 1RUM3 | Ratchet / Jeweler Axial Handle / AO Pull Coupling / Spin Cap |
| 1RUM4 | Ratchet / Jeweler Axial Handle / AO Push Coupling / Spin Cap |
| 1RUM7 | Ratchet / Jeweler Axial Handle / AO Pull Coupling / Cannulated |
| 1RUM14 | Ratchet / Jeweler Axial Handle / Short AO Coupling / Spin Cap |

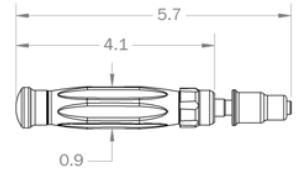

Long Jeweler Axial Handle

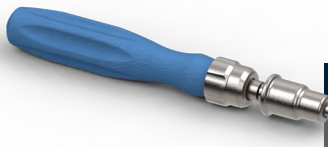

| Part # | Description |
|--------|--|
| 1RUM11 | Ratchet / Long Jeweler Handle / AO Pull Coupling / Cannulated* |
| 1RUM12 | Ratchet / Long Jeweler Handle / AO Pull Coupling / Spin Cap / Cann |
| 1RUM13 | Ratchet / Long Jeweler Axial Handle / AO Pull Coupling / Spin Cap |

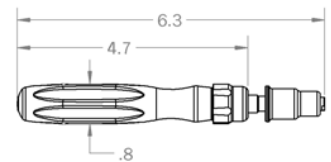

Petite Axial Handle



| Part # | Description |
|--------|--|
| 1RUM21 | Ratchet / Petite Axial Handle / AO Pull Coupling / Cannulated* |
| 1RUM22 | Ratchet / Petite Axial Handle / 3/16" SQ Coupling / Cannulated |
| 1RUM26 | Ratchet / Petite Axial Handle / AO Push Coupling / Cannulated |
| 1RUM28 | Ratchet / Petite Axial Handle / Short AO Coupling / Cannulated |

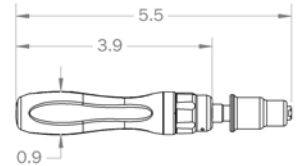

Renegade Axial Handle



| Part # | Description |
|--------|--|
| 1RUM15 | Ratchet / Renegade Axial Handle / AO Pull Coupling / Cannulated* |
| 1RUM17 | Ratchet / Renegade Axial Handle / Short AO Coupling / Cannulated |

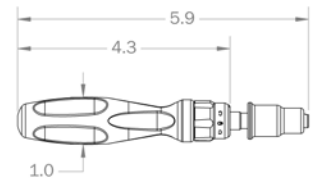

Mini Axial Handle



| Part # | Description |
|--------|--|
| 1RM1 | Ratchet / Mini Axial Handle / AO Pull Coupling / Cannulated |
| 1RM3 | Ratchet / Mini Axial Handle / ZSJ Hall Pull Coupling / Cannulated |
| 1RM4 | Ratchet / Mini Axial Handle / Large Hudson Pull Coupling / Cann |
| 1RM5 | Ratchet / Mini Axial Handle / 1/4" SQ Pull Coupling / Cannulated |
| 1RM6 | Ratchet / Mini Axial Handle / AO Push Coupling / Cannulated |
| 1RM21 | Ratchet / Mini Axial Handle / Short AO Pull Coupling / Cannulated |
| 1RM22 | Ratchet / Mini Axial Handle / AO Push-Lock Coupling / Cannulated |
| 1RM23 | Ratchet / Mini Agile Axial Handle / AO Low Profile Coupling / Cann |
| 1RM24 | Ratchet / Mini Axial Handle / AO Pull Coupling / Cann / Short Cap* |

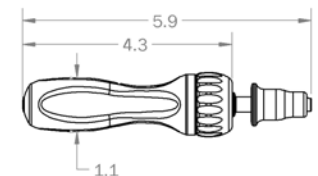

Ratcheting Handles

*Item Shown

Dimensions shown are approximate and for reference only. Contact an ARCH-MedTorque representative for exact dimensions.

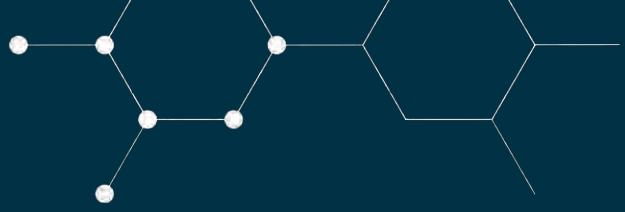

Standard Axial Handle

| Part # | Description |
|--------|---|
| 1RS1 | Ratchet / Standard Axial Handle / AO Pull Coupling / Cannulated |
| 1RS3 | Ratchet / Standard Axial Handle / ZSJ Hall Pull Coupling / Cann |
| 1RS4 | Ratchet / Standard Axial Handle / Large Hudson Pull Coupling / Cann |
| 1RS5 | Ratchet / Standard Axial Handle / 1/4" SQ Pull Coupling / Cannulated* |
| 1RS9 | Ratchet / Standard Axial Handle / 3/16" SQ Coupling / Cannulated |
| 1RS21 | Ratchet / Standard Axial Handle / 1/4" SQ Low Profile Coupling / Cann |

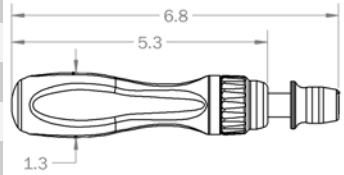

Slim-Standard Axial Handle

| Part # | Description |
|--------|--|
| 1RS11 | Ratchet / Slim-Standard Handle / AO Pull Coupling / Cannulated |
| 1RS13 | Ratchet / Slim-Standard Handle / ZSJ Hall Pull Coupling / Cannulated |
| 1RS14 | Ratchet / Slim-Standard Handle / Large Hudson Pull Coupling / Cann |
| 1RS15 | Ratchet / Slim-Standard Handle / 1/4" SQ Pull Coupling / Cannulated* |
| 1RS19 | Ratchet / Slim-Standard Handle / 3/16" SQ Coupling / Cannulated |

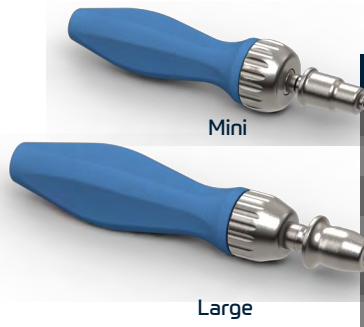
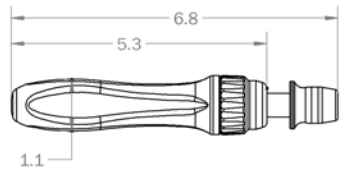

Agile Axial Handle

| Part # | Description |
|--------|---|
| 1RUM31 | Ultra-Mini Ratchet / Agile Mini Handle / AO Pull Coupling / Cann* |
| 1RL1 | Ratchet / Agile Large Handle / AO Pull Coupling / Cannulated |
| 1RL3 | Ratchet / Agile Large Handle / ZSJ Hall Coupling / Cannulated |
| 1RL4 | Ratchet / Agile Large Handle / Large Hudson Coupling / Cannulated |
| 1RL5 | Ratchet / Agile Large Handle / 1/4" SQ Coupling / Cannulated |
| 1RL9 | Ratchet / Agile Large Handle / 3/16" SQ Coupling / Cannulated* |

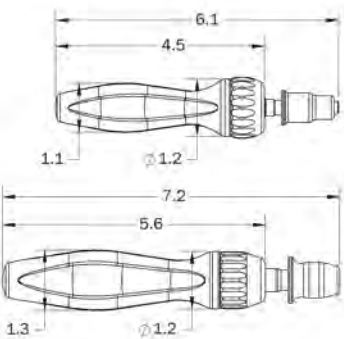

Palm Axial Handle

| Part # | Description |
|--------|---|
| 1RP1 | Ratchet / Palm Axial Handle / AO Pull Coupling / Cannulated |
| 1RP3 | Ratchet / Palm Axial Handle / ZSJ Hall Pull Coupling / Cannulated |
| 1RP4 | Ratchet / Palm Axial Handle / Large Hudson Pull Coupling / Cann* |
| 1RP5 | Ratchet / Palm Axial Handle / 1/4" SQ Pull Coupling / Cannulated |
| 1RP6 | Ratchet / Palm Axial Handle / AO Push Coupling / Cannulated |
| 1RP13 | Ratchet / Palm Axial Handle / 1/4" SQ Low Profile Coupling / Cann |

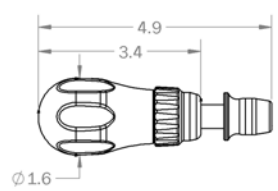

*Item Shown



Ratcheting Handles

T-Handles

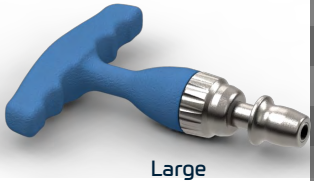
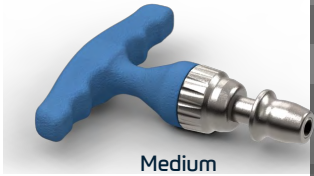

| Part # | Description |
|--------|---|
| 1RT1 | Ratchet / Small T-Handle / AO Pull Coupling / Cannulated |
| 1RT3 | Ratchet / Small T-Handle / ZSJ Hall Pull Coupling / Cannulated |
| 1RT5 | Ratchet / Small T-Handle / Large Hudson Pull Coupling / Cann |
| 1RT7 | Ratchet / Small T-Handle / 1/4" SQ Pull Coupling / Cannulated* |
| 1RT9 | Ratchet / Small T-Handle / AO Push Coupling / Cannulated |
| 1RT17 | Ratchet / Small T-Handle / 3/16" SQ Coupling / Cannulated |
| 1RT21 | Ratchet / Medium T-Handle / AO Pull Coupling / Cannulated |
| 1RT22 | Ratchet / Medium T-Handle / ZSJ Hall Pull Coupling / Cannulated |
| 1RT23 | Ratchet / Medium T-Handle / Large Hudson Pull Coupling / Cann |
| 1RT24 | Ratchet / Medium T-Handle / 1/4" SQ Pull Coupling / Cannulated* |
| 1RT25 | Ratchet / Medium T-Handle / AO Push Coupling / Cannulated |
| 1RT29 | Ratchet / Medium T-Handle / 3/16" SQ Coupling / Cannulated |
| 1RT4 | Ratchet / Large T-Handle / ZSJ Hall Pull Coupling / Cannulated |
| 1RT6 | Ratchet / Large T-Handle / Large Hudson Pull Coupling / Cann* |
| 1RT8 | Ratchet / Large T-Handle / 1/4" SQ Pull Coupling / Cannulated |
| 1RT10 | Ratchet / Large T-Handle / AO Push Coupling / Cannulated |
| 1RT18 | Ratchet / Large T-Handle / 3/16" SQ Coupling / Cannulated |
| 1RT32 | Ratchet / Mondo T-Handle / ZSJ Hall Coupling |
| 1RT33 | Ratchet / Mondo T-Handle / Large Hudson Pull Coupling* |
| 1RT34 | Ratchet / Mondo T-Handle / 1/4" SQ Pull Coupling |
| 1RT40 | Ratchet / Small T-Handle / 1/4" SQ Low Profile Coupling / Cann |
| 1RT41 | Ratchet / Medium T-Handle / 1/4" SQ Low Profile Coupling / Cann |

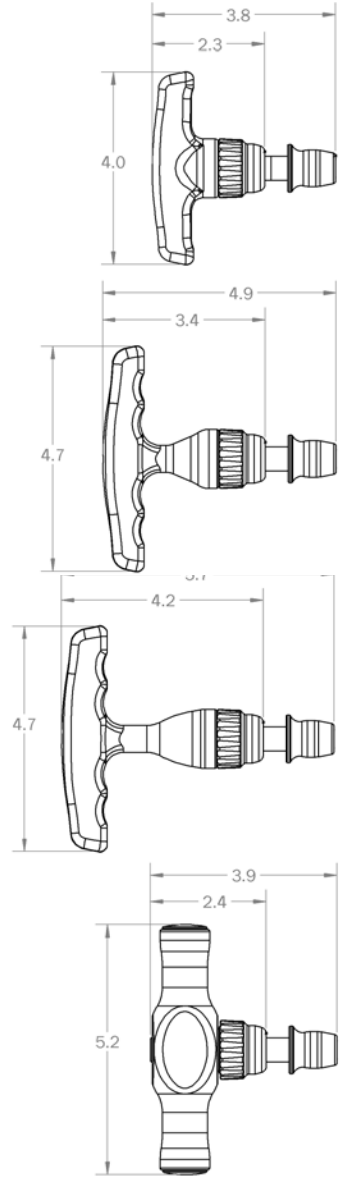

See page 21 for instructions on how to specify a ratcheting driver.

Dimensions shown are approximate and for reference only. Contact an ARCH-MedTorque representative for exact dimensions.

*Item Shown

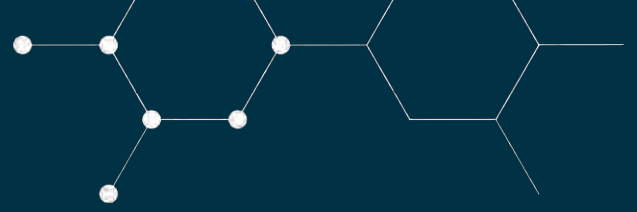

Torque-Limiting Handles with Couplings



ARCH-MedTorque's product line of torque-limiting drivers are preset to nominal value specified at time of order. The nominal torque values can span from 5 in-lbs [0.6Nm] to 125 in-lbs [14Nm] with a standard accuracy of ±10%. They are designed to limit the applied torque load in the clockwise direction and have an audible snap at actuation.

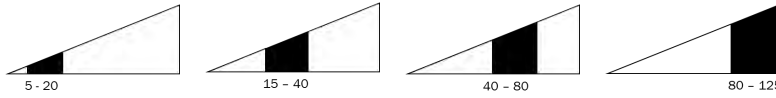

The *Torque Value Symbol* found by each product in this catalog indicates the torque range (in in-lbs) for which it is rated to help you select the torque-limiting handle that best suits your needs.



Torque Adapter

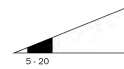

| Part # | Description |
|--------|---|
| 1TA1 | Torque-Limiting Adapter / AO Male / Pull AO Coupling* |

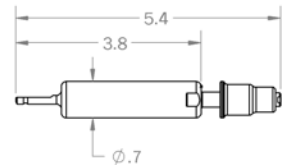

Jeweler & Long Jeweler Handle

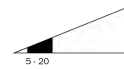

| Part # | Description |
|--------|---|
| 1TJ1 | Torque-Limiting Driver / Jeweler Handle / AO Pull Coupling* |
| 1TJ2 | Torque-Limiting Driver / Jeweler Handle / AO Pull Coupling / Spin Cap |
| 1TJ3 | Torque-Limiting Driver / Jeweler Handle / Short AO Coupling |
| 1TJ4 | Torque-Limiting Driver / Long Jeweler Handle / AO Pull Coupling* |

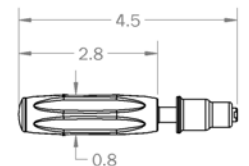

Petite Axial Handle

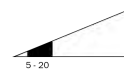

| Part # | Description |
|--------|--|
| 1TM1 | Torque-Limiting Driver / Petite Axial Handle / AO Pull Coupling* |

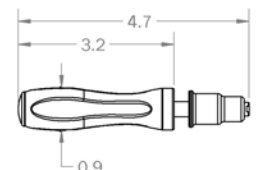

Torque-Limiting Handles



Mini Axial Handle

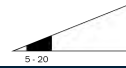

| Part # | Description |
|--------|--|
| 1TM11 | Torque-Limiting Driver / Mini Axial Handle / AO Pull Coupling* |

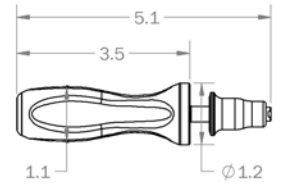

Slim-Standard Axial Handle

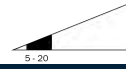

| Part # | Description |
|--------|--|
| 1TS7 | Torque-Limiting Driver / Slim Standard Axial Handle / AO Short Cplng* |
| 1TS11 | Torque-Limiting Driver / Slim Standard Axial Handle / Pull AO Coupling |
| 1TS15 | Torque-Limiting Driver / Slim Standard Axial Handle / 1/4" SQ Coupling |

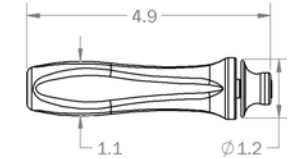

Standard Axial Handle

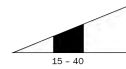

| Part # | Description |
|--------|---|
| 1TS1 | Torque-Limiting Driver / Standard Axial Handle / Pull AO Coupling |
| 1TS4 | Torque-Limiting Driver / Standard Axial Handle / Large Hudson Cplng |
| 1TS5 | Torque-Limiting Driver / Standard Axial Handle / 1/4" SQ Coupling* |

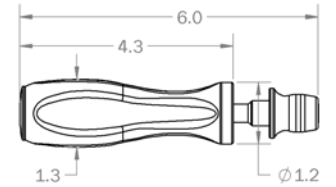

Palm Axial Handle

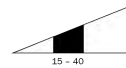

| Part # | Description |
|--------|---|
| 1TP1 | Torque-Limiting Driver / Palm Axial Handle / Pull AO Coupling* |
| 1TP4 | Torque-Limiting Driver / Palm Axial Handle / Large Hudson Coupling |
| 1TP5 | Torque-Limiting Driver / Palm Axial Handle / 1/4" SQ Coupling |
| 1TP12 | Torque-Limiting Driver / Palm Axial Handle / 3/16" SQ Push Lock Cplng |
| 1TP13 | Torque-Limiting Driver / Palm Axial Handle / 1/4" SQ Push Lock Cplng |

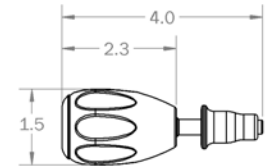

See page 21 for instructions on how to specify a torque-limiting driver.

Dimensions shown are approximate and for reference only. Contact an ARCH-MedTorque representative for exact dimensions.

*Item Shown

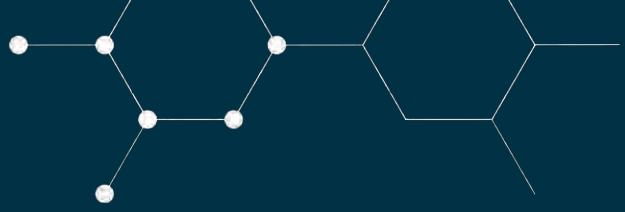

T-Handles

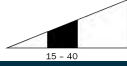

| Part # | Description |
|--------|--|
| 1TTL1 | Torque-Limiting Driver / Small T-Handle / Pull AO Coupling* |
| 1TTL4 | Torque-Limiting Driver / Small T-Handle / Z-S-J Hall Coupling |
| 1TTL7 | Torque-Limiting Driver / Small T-Handle / Large Hudson Coupling |
| 1TTL10 | Torque-Limiting Driver / Small T-Handle / 1/4" SQ Coupling |
| 1TTL2 | Torque-Limiting Driver / Medium T-Handle / Pull AO Coupling* |
| 1TTL5 | Torque-Limiting Driver / Medium T-Handle / Z-S-J Hall Coupling |
| 1TTL8 | Torque-Limiting Driver / Medium T-Handle / Large Hudson Coupling |
| 1TTL11 | Torque-Limiting Driver / Medium T-Handle / 1/4" SQ Coupling |
| 1TTL3 | Torque-Limiting Driver / Large T-Handle / Pull AO Coupling* |
| 1TTL6 | Torque-Limiting Driver / Large T-Handle / Z-S-J Hall Coupling |
| 1TTL9 | Torque-Limiting Driver / Large T-Handle / Large Hudson Coupling |
| 1TTL12 | Torque-Limiting Driver / Large T-Handle / 1/4" SQ Coupling |



Small

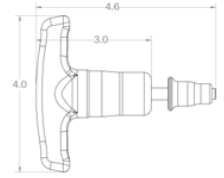

Medium

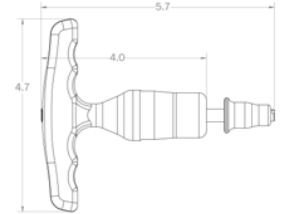

Large

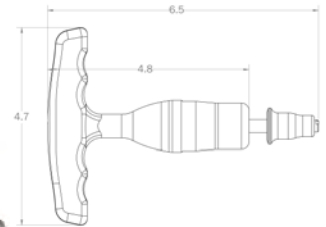

Mondo T-Handle

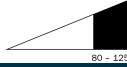

| Part # | Description |
|--------|---|
| 1TT14 | Torque-Limiting Driver / Mondo T-Handle / Z-S-J Hall Coupling |
| 1TT15 | Torque-Limiting Driver / Mondo T-Handle / Large Hudson Coupling |
| 1TT16 | Torque-Limiting Driver / Mondo T-Handle / 1/4" SQ Coupling* |

*Item Shown



Mondo

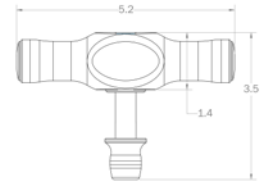

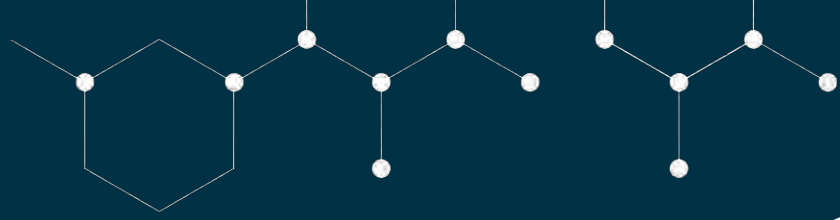

Torque-Limiting Ratchet Drivers

| Part # | Description |
|--------|--|
| 1TR7 | Torque-Limiting Ratchet / Renegade Axial Handle / AO Pull Coupling |
| 1TR6 | Torque-Limiting Ratchet / Mini Axial Handle / AO Pull Coupling |
| 1TR1 | Torque-Limiting Ratchet / Slim Standard Axial Handle / 3/16" SQ Coupling |
| 1TR9 | Torque-Limiting Ratchet / Slim Standard Axial Handle / AO Pull Coupling |
| 1TR10 | Torque-Limiting Ratchet / Slim Standard Axial Handle / 1/4" SQ Coupling |
| 1TR2 | Torque-Limiting Ratchet / Standard Axial Handle / 1/4" SQ Coupling |
| 1TR3 | Torque-Limiting Ratchet / Standard Axial Handle / AO Pull Coupling |
| 1TR4 | Torque-Limiting Ratchet / Standard Axial Handle / ZSJ Coupling |
| 1TR5 | Torque-Limiting Ratchet / Standard Axial Handle / Large Hudson Coupling |

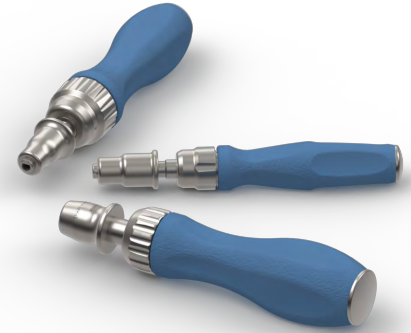

How to Specify Your Handle:

ARCH-MedTorque's part numbering scheme makes it easy to specify a standard item. Use the quick guide below to build the product you need. Illustration prints of catalog products are available upon request.

Handle Component:

Example: 3HC1-C01-P
Long Curette Axial Handle / Black Silicone / Plug



Ratcheting Driver:

Example: 1RM1-C01
Ratchet / Mini Axial Handle / AO Pull Coupling / Cannulated



Torque-Limiting Driver:

Example: 1TS4-25-C01
Torque-Limiting Driver / Standard Axial Handle / Large Hudson Coupling / 25 in-lbs / Black Silicone

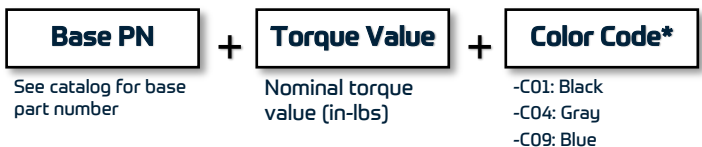

* Contact an ARCH-MedTorque representative for custom color code designation.

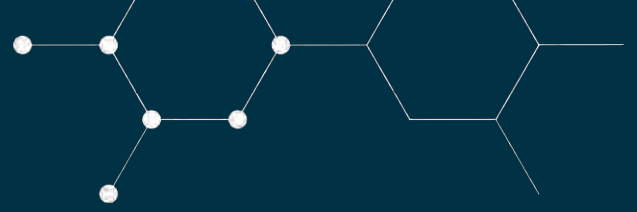

Disc Prep and Spinal Instrumentation



Our **Spinal Instrument** offering includes:

- Rod Benders
- Rod Grippers/ HOLDERS
- Rod Persuaders
- Rod Pushers
- Counter Torque Wrenches
- Slap Hammer & Drivers
- Implant Inserters

Choose from our standard offering or have one of our engineers customize to your specifications.

Our **Disc Prep Instrument** offering includes:

- Curettes (Cup, Ring, Teardrop)
- Rasps
- Elevators
- Osteotomes



Contact your ARCH-MedTorque representative for more information on customization options on these and other products offerings.



Other Products & Services

ARCH-MedTorque's broad and accomplished background in manufacturing instruments for the orthopedic industry is unparalleled. We excel in making the complex simple by leveraging our comprehensive internal capabilities and expertise. As your solution-oriented partner, we're committed to delivering improved outcomes.



Other Products & Services



ARCH[®]

MEDTORQUE

(844) MEDTORQ | sales@medtorque.com
www.medtorque.com

ISO 13485:2016 Certified | FDA Registered



CE marking is available on select standard configurations of ARCH-MedTorque's Fixed, Ratchet and Torque products.

© 2024 MedTorque, Inc. dba ARCH-MedTorque All rights reserved.

TRI-GEAR™ Ratchet Patent # 9,511, 484

PANTONE® is a registered trademarks of Pantone.

MTMK-01-001 Rev. K